



Friedrich[®]
Riveting Technology
and Assembly Systems

RADIAL POINT RIVETING TECHNOLOGY

THE ORIGINAL

CNC RIVETING MACHINES

RADIAL POINT RIVETING MACHINES

ELECTRICALLY-OPERATED PRESSES

SPECIAL-PURPOSE MACHINES

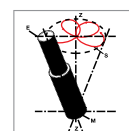
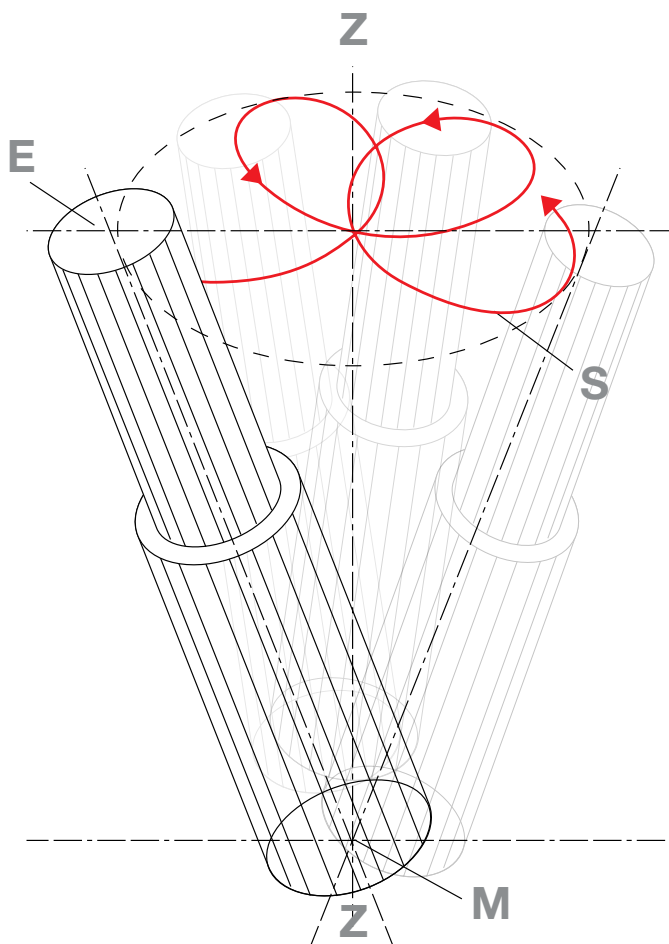

Riveting technology

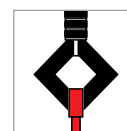

Assembly systems

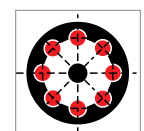

Special-purpose machines

The Friedrich Riveting Technology

The company D. Friedrich Maschinen- und Werkzeugbau GmbH & Co. KG, or, more concisely, FMW, was founded in the year 1948 at Remshalden near Stuttgart. The family-run company develops and produces riveting machines, special-purpose machines and electrically-operated presses for the automotive, fittings and electrical industries. The company's appearance is characterised by modern factory equipment and up-to-date manufacturing facilities. An innovative management, highly qualified engineers and electronics specialists as well as well-trained technicians and skilled labour with many years of experience provide a sound basis for a successful corporate history. Engineering know-how, innovative capacity and an efficient Quality Management System to DIN ISO 9001 guarantee a consistently high quality of the Friedrich products. Premium-quality products, customised all-in-one solutions, competent consultation and a comprehensive service make Friedrich a successful and reliable partner also at international level.



History

- 1948 Foundation of the Maschinen und Werkzeugbau GmbH
- 1965 Development of the mechanical rotary indexing table TM 150
- 1966 Invention of Friedrich radial point riveting technology and issue of patent (Pat. No. 1 552 838)
- 1970 Production of the first assembly machine
- 1971 Development of the hydraulically-operated rotary indexing table TH 560
- 1975 Development of the first electrically-operated press ETP 6 worldwide (Pat. No. 27 37 231)
- 1978 Production of forced-air cooled hydraulic units
- 1980 Delivery of the 2,000th riveting machine
- 1983 Start of the roll-forming technology
- 1984 Presentation of the first CNC riveting machine worldwide
- 1986 Development of Friedrich's 'Nietcontrol' control unit
- 1987 Development of the integrated measurement system (Pat. No. 37 15 905)
- 1989 The second generation of D. Friedrich takes command
- 1991 Extension of the assembly shop
- 1995 Delivery of the 250th CNC riveting machine
- 2000 Introduction of the QM system to DIN ISO 9001
- 2001 Start of the bushing technology
- 2002 Development work in the field of rivet clinching, in cooperation with Fraunhofer Institut
- 2005 Development of the first CNC power assisted bushing machine
- 2006 A new assembly shop is built
- 2007 The biggest CNC riveting machine with a 2000 mm rotary indexing table and a traversing range of 500x1200mm is built
- 2007 A patent is granted on the safety riveting machine with accident prevention riveting head (Pat. No. 10 2005 047 191)
- 2008 Development of the first 5-axis CNC riveting machine
- 2009 Presentation of a hand-held riveting machine
- 2010 The 750th CNC riveting machine is delivered
- 2011 Introduction of the CNC riveting machine with handling robot as standard equipment
- 2014 Delivery of the first servo-roll-forming machine



1955



1972



2006

 **Table of contents**

The company	2
History of riveting technology	4
A comparison of riveting methods	5
Examples of riveted joints	6 - 7
Radial point riveting machines	8 - 13
• Column-type riveting machines	8
• Pedestal-type riveting machines	9
• Riveting units with pneumatic operation	10
• Riveting units with hydraulic operation	11
• Safety riveting machines	12
• Nietmax, the portable riveting machine	13
Accessories	14 - 16
• Riveting tools	14
• Machine equipment	15
• Installation variants	16
Controls / software	17 - 21
• Standard controls	17
• Riveting process monitoring	18
• Nietcontrol	19
• Process visualisation QAPV	20
• CNC controls	21
CNC riveting machines	22 - 27
• CNC riveting machines with indexing table	22
• CNC riveting machines with transfer system	23
• CNC riveting machines with machine table	24
• CNC riveting machines used as a module	25
• CNC riveting machines with 5 axes	26
• CNC riveting machines with robot	27
Electrically-operated presses	28 - 29
• P602 - closed version	28
• P602 - open versions	29
Special-purpose machines	30
Assembly systems	31
Roll-forming machines	32
Bushing machines	33
Service	34
Directions	35
Sales and distribution	36

THE HISTORY OF RIVETING TECHNOLOGY

● The history of riveting technology

In the beginning there were: man, his hammer and a rivet head maker (riveting die). Riveting as one of the oldest methods of connecting two components in an inseparable way is already known since early history. Riveted joints were produced by peening rivets over with a hammer. As industrialisation was on the rise, also presses or mechanical hammers for metal working were gaining ground but were soon replaced by specific riveting machines. The great amount of force to be exerted along with high noise levels on the one hand and, on the other hand, the changes in the structure and the embrittlement of the rivets were less and less accepted by users demanding higher quality standards. Though the orbital riveting technology did bring some improvements in its wake, the hardenings of the rivet structure and the damage to the closing head surface still remained.

● The invention that revolutionised riveting

In the year 1966 a new technology was developed by Friedrich engineers who thus laid the foundation of what was to become, and still is, the most efficient and economic technology:

The Friedrich Radial Point Riveting Technology

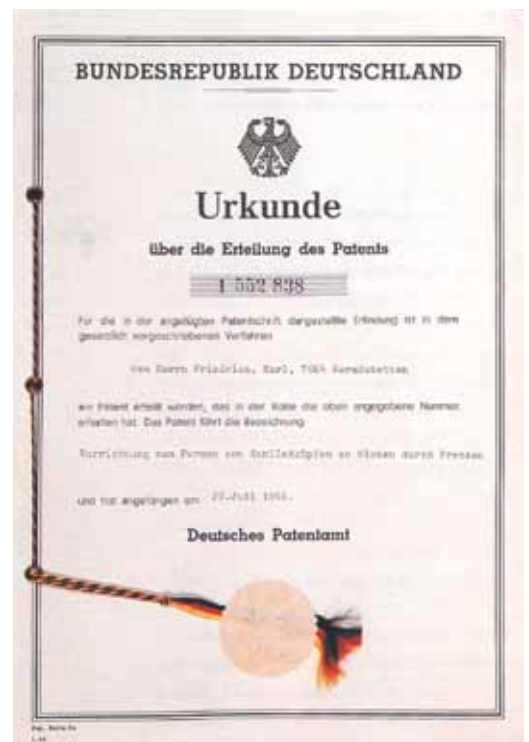
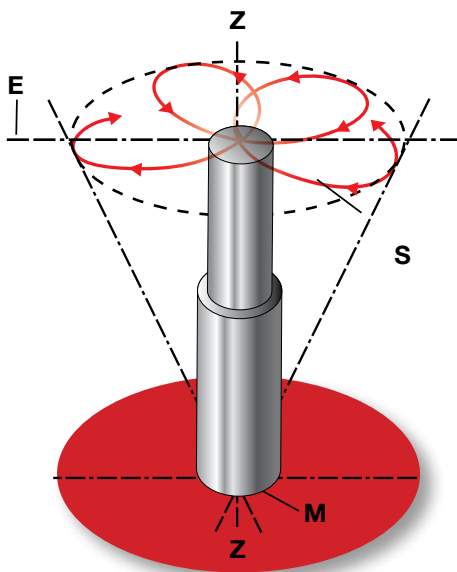

The advantages of the radial point riveting technology:

- low effort combined with a high riveting power
- low-noise and uniform rivet shaping
- low transverse forces, therefore workpiece fastening is easy
- particularly suited to meet quality assurance requirements due to the vertical position of the riveting die
- minimum friction, little heat development and a smooth closing head surface
- gentle change to the rivet material structure
- no rotation of the die, therefore also stamping is possible
- allows to achieve an easily dimensionable bearing stress

● Microsections of structures obtained by different riveting methods

These microsections show the differences in structural conditions obtained by the different riveting methods for shaping the rivets. It is with the radial point riveting method only that the material structure remains unchanged to the greatest possible extent.

Very high degree of hardening

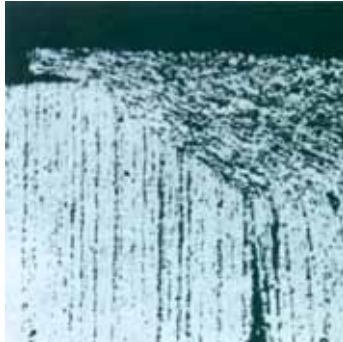

Hardening well visible

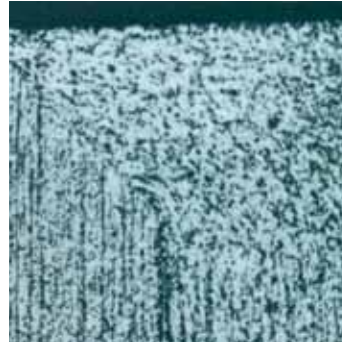

Low structural change

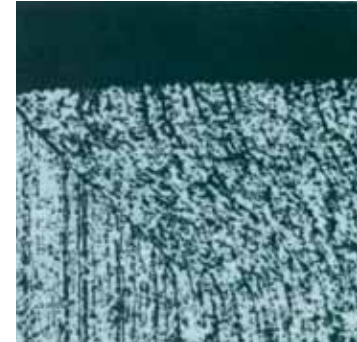

Pressing and hammering

The rivet is shaped either by pressing or by hammering. Pressing uses a one-time pressure applied to the rivet, while in hammering the rivet is beaten several times in axial direction. The disadvantages: both methods need great efforts and cause much noise.

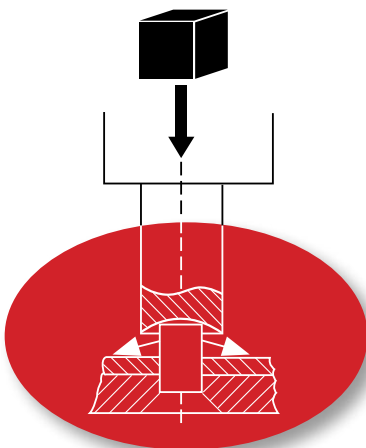

Orbital riveting

Describing an orbital path K, the end E of the riveting die rotates about the centre line Z of the riveting spindle. The longitudinal axis of the riveting die intersects the riveting spindle axis in point M. The shaping of the rivet takes place on a contact line whose length is identical to the closing head radius.

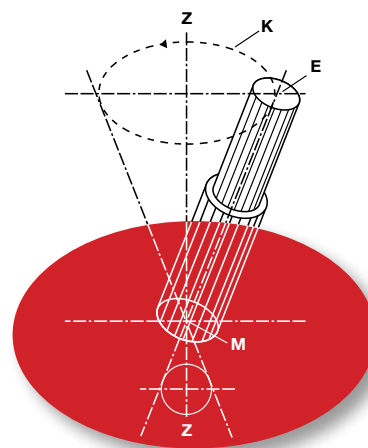

Radial point riveting

The end E of the riveting die describes a hypocycloid loop path S. Here, too, the longitudinal axis of the riveting die intersects the riveting spindle axis in point M. Due to the hypocycloid drive the angle of attack of the die constantly changes between 0° and X° . The shaping of the rivet is done by point contact, forming the rivet material outward from the centre.

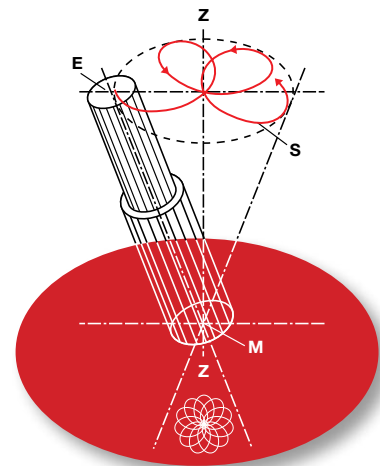

EXAMPLES OF RIVETED JOINTS

● **A choice from a large number of possible applications, all riveted on Friedrich radial point riveting machines and CNC riveting machines**

Apart from the typical applications there is also a large number of specific riveting problems for which the Friedrich radial point riveting technology offers solutions, for example the gentle riveting of electroplated rivets or highly sensitive electronic components as well as the processing of unstable workpieces or workpieces difficult to access, using downholders or angled riveting dies. The draw riveting of parts with a sophisticated geometry is a specific solution variant.



Wiper arm - Seat belt buckle - Seat belt pretensioner



Saw chain - Window handle - Sprocket

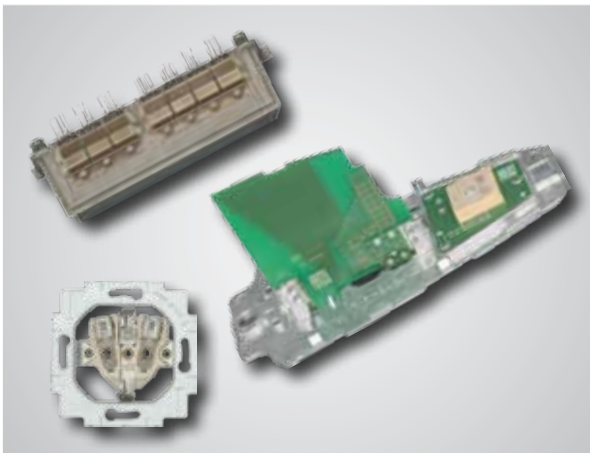

Cooling element - Socket - Roof-mounted aerial



Quick-acting clamp - Ball joint - Rope clamp



Side panel of circuit breaker - Drive mechanism for throttle valve - Passenger car door lock



End plate - Brake lining - Diaphragm governor

● Examples of riveted joints

Examples of application and riveting tasks that can only be implemented using the Friedrich radial point riveting technology in combination with a special riveting die.



Recessed riveting die



Cranked riveting die



Corrugated riveting die



Drawing riveting die

RADIAL POINT RIVETING MACHINES

● Column-type riveting machines

- pneumatically operated riveting machines (plug and play) for universal use
- modular configuration, compact design
- machine table and housing made of grey cast iron
- housing can be swivelled 180° around the column to enable a processing of bulky workpieces
- easy height adjustment using a crank
- riveting spindle stroke setting
- machine table with centre hole and T-slot
- two-hand control at the machine table
- various electric controls available
- broad range of accessories for any application



Technical Data:	Column-type Riveting Machines			
	N 000	N 100 S	N 100	N 200
Rivet diameter (Rm=370N/mm ²)	1 - 3 mm	1 - 4 mm	2 - 6 mm	3 - 10 mm
Riveting power at 6 bar	1.8 kN	3 kN	6 kN	12 kN
Spindle stroke	5 - 30 mm	5 - 30 mm		5 - 30 mm
Operating pressure	1 - 6 bar	1 - 6 bar		1 - 6 bar
Motor 230/400V 50Hz	0.25 kW	0.74 kW		0.74 kW
Cylinder volume	max. 0.25 l	max. 0.35 l	max. 0.7 l	max. 1.45 l
Weight	approx 48 kg	approx 145 kg		approx 145 kg
Working area	1 - 95 mm	2,5 - 205 mm		2,5 - 205 mm
Projection	127 mm	168 mm		168 mm
Clamping area	225x175 mm	320x290 mm		320x290 mm

● Pedestal-type riveting machines

- riveting machines (plug and play) for universal use
- machine table and housing made of grey cast iron
- two-hand control at the machine table
- easy height adjustment using a crank
- stroke setting with adjusting ring on the riveting unit
- available in pneumatically- or hydraulically-operated versions
- various electric controls available
- modular configuration, compact design, robust workmanship
- broad range of accessories and riveting tools for any application
- machine table with centre hole and T-slot to mount devices on it



Pneumatic
pedestal-type riveting machine
R 100



Pneumatic
pedestal-type riveting machine
N 300



Pneumatic
pedestal-type riveting machine
N 400



Hydraulic
pedestal-type riveting machine
N 510

Technical Data:

Pedestal-type riveting machines

	R100	R 100 S	N 300	N 400	N 510	N 510/72
Rivet diameter (Rm=370N/mm²)	2 - 6 mm	2 - 7 mm	3 - 11 mm	4 - 13 mm	4 - 18 mm	
Riveting power at 6 bar	6.5 kN	8.2 kN	16 kN	25 kN	40 kN	
Spindle stroke	5 - 30 mm		5 - 40 mm	5 - 40 mm	5 - 50 mm	5 - 72 mm
Operating pressure	1 - 6 bar		1 - 6 bar	1 - 6 bar	10 - 70 bar	
Motor 230/400V 50Hz	0.37 kW		0.74 kW	0.74 kW	1.9 kW	
Cylinder volume	max. 0.58 l	max. 0.78 l	max. 1.86 l	max. 2.08 l	-----	
Weight	approx 98 kg		approx 330 kg	approx 330 kg	approx 420 kg	
Working area	30 - 175 mm		2,5 - 245 mm	2,5 - 224 mm	17 - 342 mm	5 - 342 mm
Projection	131 mm		200 mm	200 mm	147 mm	
Clamping area	240 x 230 mm		368 x 339 mm	368 x 339 mm	368 x 339 mm	

RADIAL POINT RIVETING MACHINES

Riveting units with pneumatic operation

- riveting machines for special applications
- sturdy cast housings, robust workmanship, powerful standardised motors
- modular configuration, compact design
- driving motor adaptable to various installation scenarios
- particularly suited for installation in special-purpose plants
- broad range of accessories and riveting tools for any application
- also available as complete workstation with C-shaped frame and control
- customised devices available in many configurations and with any degree of automation



Pneumatic radial point riveting unit
RE 100

Pneumatic radial point riveting unit
NE 200

Pneumatic radial point riveting unit
NE 300

Pneumatic radial point riveting unit
NE 400

Technical Data:	Riveting Units, pneumatic					
	RE 100	RE 100 S	NE 100	NE 200	NE 300	NE 400
Rivet diameter (Rm=370N/mm²)	2 - 6 mm	2 - 7 mm	2 - 6 mm	3 - 10 mm	3 - 11 mm	4 - 13 mm
Riveting power at 6 bar	6.5 kN	8.2 kN	6 kN	12 kN	16 kN	25 kN
Spindle stroke	5 - 30 mm		5 - 30 mm	5 - 30 mm	5 - 40 mm	5 - 40 mm
Operating pressure	1 - 6 bar		1 - 6 bar	1 - 6 bar	1 - 6 bar	1 - 6 bar
Motor 230/400V 50Hz	0.37 kW		0.74 kW	0.74 kW	0.74 kW	0.74 kW
Cylinder volume	max. 0.58 l	max. 0.78 l	max. 0.7 l	max. 1.45 l	max. 1.86 l	max. 2.08 l
Weight	approx 34 kg		approx 55 kg	approx 55 kg	approx 65 kg	approx 75 kg

● Riveting units with hydraulic operation

- riveting machines for special applications
- sturdy cast housings, robust workmanship, powerful standardised motors
- modular configuration, compact design
- extended spindle stroke: NE 210 - 80 mm
NE 510 - 72 mm
- driving motor adaptable to various installation scenarios
- particularly suited for installation in special-purpose plants
- broad range of accessories and riveting tools for any application
- also available as complete workstation with C-shaped frame and control
- customised devices available in many configurations and with any degree of automation



Technical Data:	Riveting Units, hydraulic			
	NE 210	NE 210/80	NE 510	NE 510/72
Rivet diameter (Rm=370N/mm ²)	3 - 10 mm		4 - 18 mm	
Riveting power at 6 bar	12 kN		40 kN	
Spindle stroke	5 - 50 mm	5 - 80 mm	5 - 50 mm	5 - 72 mm
Operating pressure	10 - 70 bar		10 - 70 bar	
Motor 230/400V 50Hz	0.74 kW		1.9 kW	
Cylinder volume	-----		-----	
Weight	appox 47 kg		appox 85 kg	

**Further installation variants
see page 16**

RADIAL POINT RIVETING MACHINES

Safety riveting machines

In accordance with safety regulations the electrical activation of the pneumatic valves is of the two-channel type. Both valves must be actuated to allow a working cycle to be initiated. If a malfunction of a safety component occurs no pressure will be built up after re-start. No dangerous movement will come about. Protection device monitoring is cyclic.

The use of a riveting machine with safety riveting head is recommended if:

- the riveting machine is operated by means of a pedal switch and not by means of the safe two-hand control.
- the safety distance between the riveting die and the rivet holder is not observed.

That will be the case if workpieces have to be held with both hands during the riveting operation and the riveting spindle is started by the pedal switch. If during such an operation the safety distance of 4 mm between the riveting die and the rivet holder is exceeded there is a very grave risk of accidents. The design of the accident prevention riveting head ensures that the dangerous movement of the riveting die is stopped the very moment the die touches the operator's hand. The riveting spindle immediately moves back to its home position. The electrical activation of the valves takes place via an approved safety PLC. A signal lamp flashing at determined intervals indicates the respective working orders. If a failure of the protection device is identified during the working process a restart will not be allowed any more. In the event of malfunctions the downward movement of the riveting head is locked. Prior to starting any work the protection device must be triggered once on purpose in order to obtain release from the control.



Technical Data:	N 100	N 200
Rivet diameter (Rm=370N/mm²)	2 - 6 mm	3 - 10 mm
Riveting power at 6 bar pneu.	6 kN	12 kN
Spindle stroke	5 - 30 mm	5 - 30 mm
Operating pressure	1 - 6 bar	1 - 6 bar
Motor 230/400V 50Hz	0.74 kW	0.74 kW
Cylinder volume	max. 0.7 l	max. 1.45 l
Weight	approx 162 kg	approx 162 kg
Working area	2,5 - 180 mm	2,5 - 180 mm
Projection	168 mm	168 mm
Clamping area	320x290 mm	320x290 mm
Effective stroke	24 mm	24 mm



● „Nietmax“, the portable riveting machine for flexible use

- pneumatically-operated radial point riveting unit NE 200
- a number of different riveting heads and downholders can be used
- solid steel bow with workpiece holding fixture
- spring-mounted cable pull with balancer for easy handling
- cable carrier for longer distances to cover
- two-hand control ensures safe riveting operation
- optionally standard control or „Nietcontrol“ control unit



The machine is directed manually, quickly and with little effort to any desired riveting position, its weight being neutralised by a spring-mounted cable pull. After having been released the machine will remain balanced within its working range. What makes the “Nietmax” NF 203 so unique is its integrated “Nietcontrol” control unit with patented measuring systems. On request the quality assurance programme QAPV can be networked via interface to external operating systems. The machine is directed manually to the place where a riveting operation is to be done. The rivet positions itself in a central position in an anvil of appropriate shape. At machine start via the two-hand control the spring-mounted downholder moves the riveting machine automatically to the correct riveting position. The parts to be riveted are pressed together. The projection of the rivet is measured in this position. The power flow is transmitted without any significant resilience via a solid C-shaped bow.

Technical Data:

	NE 200
Rivet diameter (Rm=370N/mm²)	1 - 10 mm
Riveting power at 6 bar pneu.	12 kN
Spindle stroke	bis 30 mm
Operating pressure	1 - 6 bar
Motor 230/400V 50Hz	0.74 kW
Cylinder volume	max. 0.7 l
Weight	145 kg

Riveting tools

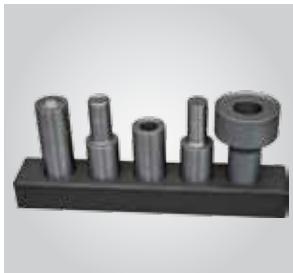

Riveting dies 40-180 mm



Special-version riveting dies

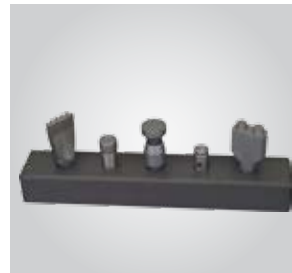

Stamp dies



Riveting dies with downholders from Elastomer



Riveting dies for draw riveting



Square riveting die

Riveting die diameters

Ø 8 / Ø 10 / Ø 14 / Ø 30

Riveting die lengths

40 - 180 mm

Riveting die shapes

as requested by customer

Riveting dies and closing head shapes

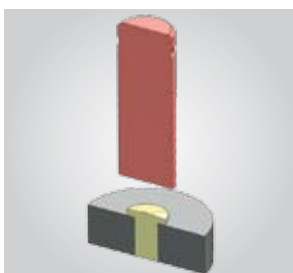

convex

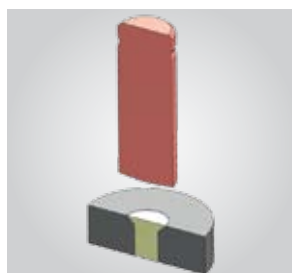

flat into countersunk

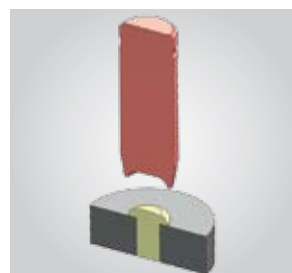

shaped

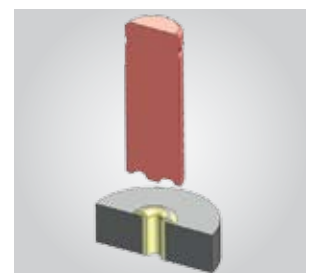

tubular rivet crimped externally

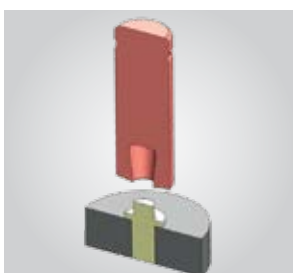

shear riveting



double

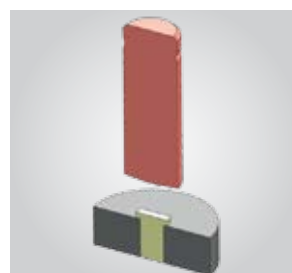

flat

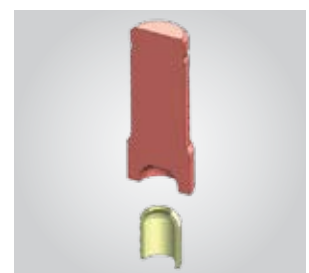

tubular rivet crimped internally

Extras



Riveting heads with die anti-rotation device



Special-purpose riveting heads



Quick-change riveting heads



Angled riveting heads



Multi-spindle heads for radial-point riveting



Multi-spindle heads for orbital riveting



Downholders / Downholders with measuring system



Positionable downholders



Rolling heads



Spindle extensions



Extended machine columns

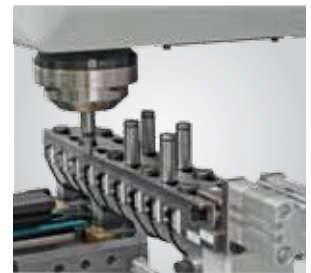

Riveting die changer



Rivet holders



Workpiece holding fixtures



Workpiece carriers



Riveting supports for bulky components

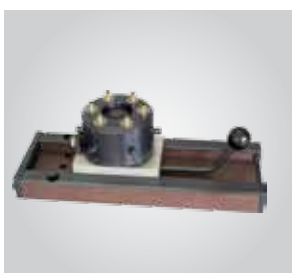

Sliding fixtures, manual and automatic



Rotary indexing table

Further accessories and extras can be made available on customer's request

Special accessories



Machine stands



C-frames



Machine frames



Handling and grab containers

Further special accessories and extras can be made available on customer's request

Installation variants



2 units arranged in parallel



Flange can be swivelled in steps of 30°



Motor in lower rear position



Motor in lower front position, flange can be swivelled in steps of 30°



Motor in upper position, flange can be swivelled in steps of 30°

Standard control with pedal switch actuation

Outline of advantages:

- easy to operate
- robust design
- purely hardware-controlled
- automatic and setting-up modes of operation
- riveting for a determined time, to be set at the potentiometer
- riveting until reaching the mechanical stop
- riveting at a determined pressure and for a determined time
- electric piece counter (optional)
- two starting methods:
 - pedal switch
 - start by proximity switch when a slide is used



Standard control with two-hand control actuation

Outline of advantages:

- easy to operate
- robust design
- safety control
- automatic and setting-up modes of operation
- riveting time can be set at the digital display
- riveting until reaching the mechanical stop
- riveting at a determined pressure and for a determined time
- electric piece counter
- three starting methods:
 - safe two-hand control
 - pedal switch (optional)
 - start by proximity switch when a slide is used (optional)



Riveting process monitoring with the Friedrich Nietcontrol

The **Friedrich Nietcontrol** is an operating system with a patented measurement method for radial point riveting machines.

Friedrich Nietcontrol's successful formula is:

optimal quality assurance = minimum operating effort + maximum operational safety

The Friedrich Nietcontrol checks all the riveted joint's significant parameters. The parameters are monitored by the displacement distances and the riveting times. The relevant data is shown on the display and saved under a program number. Any faults and errors are detected and shown.

The displacement distance measurement is the most important parameter for quality assurance. It means that the riveting machine can reproduce and very precisely re-measure the closing head height. The machine can also document and check the given tolerance compliances.

The riveting die is placed in a vertical position and the initial length of the non-riveted rivet is measured at a low pressure. The riveting operation will not start, if the measuring value is not within its tolerance range. As the rivet is not deformed during measuring process, the rivet or a faulty part can be replaced by a new one. Thus avoiding rejects and saving valuable components. The value (Z or H) is constantly measured and monitored during the riveting process.

The **Friedrich QAPV (Quality Assurance and Process Visualization) software** continuously records the measured values provided by the control system and uses them to calculate the machine capability as well as the processing capability.

Friedrich radial point riveting machine with length measurement

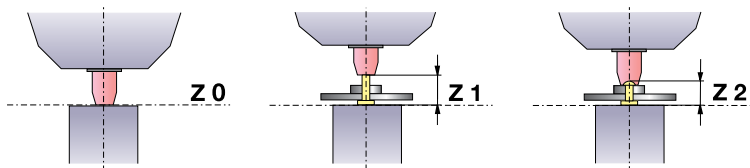

With the aid of length measurement, the length of the non-riveted rivet (Z1) is measured. The riveting process is finished when the final value (Z2) is reached.

Friedrich radial point riveting machine with projection measurement

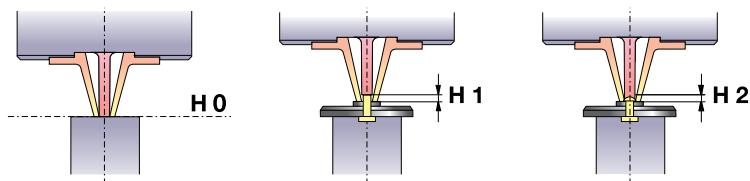

The projection of the rivet (H1) is measured with the aid of path length difference between the riveting die and measuring inset of the non-riveted rivet. At the same time, the projection measurement is used to check the presence of all components of the future rivet joint. The riveting operation is finished when the final value (H2) is reached.

Friedrich radial point riveting machine by Delta-measurement (deviation riveting)

The Delta-measurement deviation riveting system rivets from the initial length (Z1 or H1) to a deviation value. The riveting operation is finished when the deviation value (Z or H) is riveted.

Friedrich radial point riveting machine with length and projection measurement

There is the possibility to equip a machine with length and projection measurement system. So the machine measures the rivet's length and projection and also checks the presence of all components. The riveting operation is finished when the final value (H2 or Z2) is reached.

Nietcontrol

Friedrich radial point riveting machine with integrated measuring system

Length measurement and/or rivet projection measurement

Control functions:

- 8-key operator panel allows for easy operation
- menu control
- error evaluation with optical display
- teach-in function or fixed-value entry
- copying function for riveting parameters
- up to 30 different riveting points, at option with binary coded addressability
- diagnosis of inputs and outputs
- riveting pressure freely adjustable for each riveting point, pneumatic machines 1-6 bar, hydraulic machines 10-70 bar
- riveting time slot for rivet material monitoring
- display of current measuring values
- positioning of the riveting die to vertical position to improve the measuring accuracy
- variable speed of riveting motor
- multifunction counter with integrated preselection counter
- serial output of specified and actual values
- measuring function
- pressing-in function with riveting die aligned



Variable starting functions:

- two-hand control
- pedal switch
- proximity switch, e.g. when slides are used
- primary control, e.g. PLC with binary coded selection of the riveting points

Other functions:

- manual or automatic slide with riveting point selection, e.g. 2 successive riveting operations
- control of index cylinders and/or lifting stations
- a faulty rivet can be retained (pinched); rejects can only be removed if previously acknowledged separately
- can be integrated into manufacturing lines as an independent line module or into special-purpose machines (e.g. rotary indexing tables) as a single station
- length measuring system for roll-forming operations (rolling head)
- special solutions for your particular application

Process visualisation QAPV

Programme QAPV (Quality Assurance and Process Visualization) is a 32 bit application for PCs under Microsoft Windows® and has been purpose-developed for the riveting machines of D. Friedrich GmbH & Co. KG. The purpose of the QAPV software is to adopt and transfer, archive and visualise the process data recorded during manufacture.

The QAPV software can be run directly on the industrial PC installed on the machine, or on an external PC which may be located for example in the foreman's office. The data link to several machines is ensured via an Ethernet network (TCP/IP).

If the data link between the QAPV software and the machine PLC is active, after each production step the process values determined during processing are read out from the PLC and saved in the SQL database. The QAPV software can be run offline, without a connection to the machine, for example to evaluate the archive files copied from the machine on an external office PC.

On page „Messwerte Nieten“ the riveting process values logged by all machines are displayed, edited statistically and represented graphically provided that they meet the filtering conditions set previously and that the maximum number of data records that can be displayed is not exceeded. The displays are updated automatically when new data records meeting the current filtering conditions are received from the connected machine controls.

The diagram represents the respective logged minimum, actual and maximum values of the axis activated with the big statistics buttons. The min. and max. limits are plotted as red curves while the actual values are shown as a green one. The table lists the logged process values matching the active filter settings. The buttons used to switch between the graphically displayed process values show the average value, the standard deviation and the CpK value.

Archiving the Process Values:

To keep the database small and, in consequence, to keep the access to it fast, the QAPV software package includes an archiving programme. Every month is given its own archive file in which all data, including the list of data sources and the plaintext error messages, is stored.

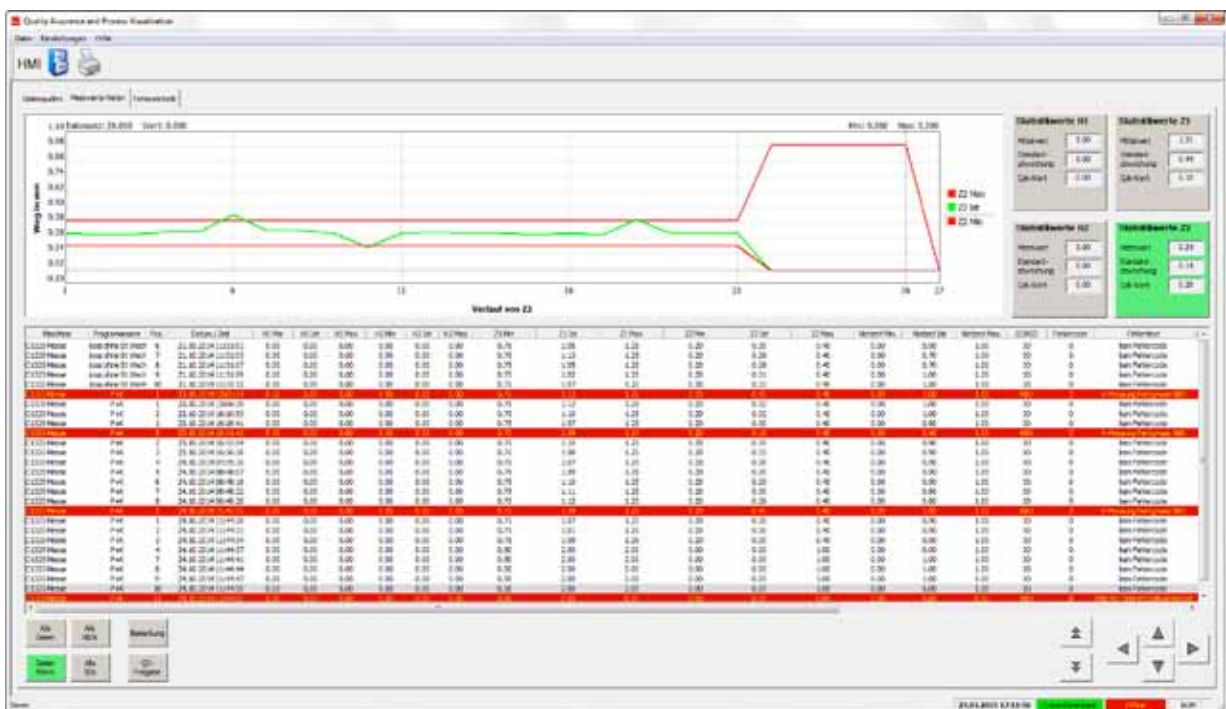

CNC control

- control panel with touchscreen 12.1“
user interface based on WINDOWS CE 4.2, Microsoft trademark

Alternatively:

- IPC with touchscreen 15“
user interface based on WINDOWS® 7 embedded, Microsoft trademark

- CoDeSys Soft PLC with integrated HMI
- hardware- and platform-independent
- CAN open networking
- Ethernet connection
- positioning control for up to 5 coordinate axes
- language change
- storage capacity for an almost unlimited number of riveting programmes
- riveting programmes can be transferred and archived via a USB interface
- online process data acquisition with the Friedrich QAPV software (made by Friedrich)
- user interface in table form to create riveting programmes
- remote maintenance and remote action are possible via Ethernet (e.g. VPN)
- communication with controls and components of the most different kinds, e.g. Profibus, OPC server

CNC control

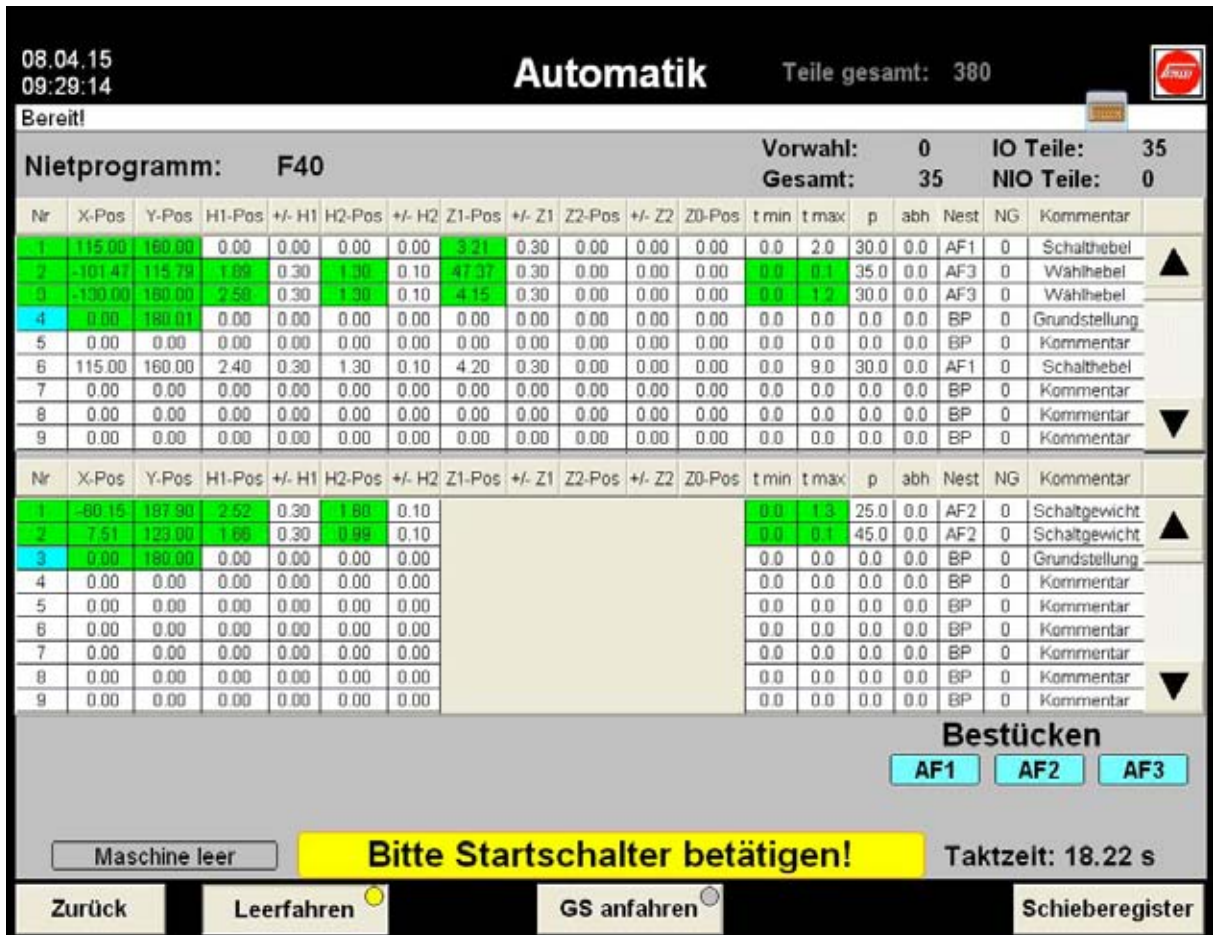

08.04.15
09:29:14

Automatik

Teile gesamt: 380

Bereit!

Nietprogramm: **F40** Vorwahl: 0 IO Teile: 35
Gesamt: 35 NIO Teile: 0

Nr	X-Pos	Y-Pos	H1-Pos	+/- H1	H2-Pos	+/- H2	Z1-Pos	+/- Z1	Z2-Pos	+/- Z2	Z0-Pos	t min	t max	p	abh	Nest	NG	Kommentar
1	115.00	160.00	0.00	0.00	0.00	0.00	3.21	0.30	0.00	0.00	0.00	0.0	2.0	30.0	0.0	AF1	0	Schalthebel
2	-101.47	115.79	1.69	0.30	1.30	0.10	47.37	0.30	0.00	0.00	0.00	0.0	0.1	35.0	0.0	AF3	0	Wahlhebel
3	-130.00	160.00	2.58	0.30	1.30	0.10	4.15	0.30	0.00	0.00	0.00	0.0	1.2	30.0	0.0	AF3	0	Wahlhebel
4	0.00	160.01	0.00	0.00	0.00	0.00	0.00	0.00	0.00	0.00	0.00	0.0	0.0	0.0	0.0	BP	0	Grundstellung
5	0.00	0.00	0.00	0.00	0.00	0.00	0.00	0.00	0.00	0.00	0.00	0.0	0.0	0.0	0.0	BP	0	Kommentar
6	115.00	160.00	2.40	0.30	1.30	0.10	4.20	0.30	0.00	0.00	0.00	0.0	9.0	30.0	0.0	AF1	0	Schalthebel
7	0.00	0.00	0.00	0.00	0.00	0.00	0.00	0.00	0.00	0.00	0.00	0.0	0.0	0.0	0.0	BP	0	Kommentar
8	0.00	0.00	0.00	0.00	0.00	0.00	0.00	0.00	0.00	0.00	0.00	0.0	0.0	0.0	0.0	BP	0	Kommentar
9	0.00	0.00	0.00	0.00	0.00	0.00	0.00	0.00	0.00	0.00	0.00	0.0	0.0	0.0	0.0	BP	0	Kommentar

Nr	X-Pos	Y-Pos	H1-Pos	+/- H1	H2-Pos	+/- H2	Z1-Pos	+/- Z1	Z2-Pos	+/- Z2	Z0-Pos	t min	t max	p	abh	Nest	NG	Kommentar
1	-60.15	187.90	2.52	0.30	1.60	0.10						0.0	1.3	25.0	0.0	AF2	0	Schaltgewicht
2	7.51	123.00	1.66	0.30	0.99	0.10						0.0	0.1	45.0	0.0	AF2	0	Schaltgewicht
3	0.00	160.00	0.00	0.00	0.00	0.00						0.0	0.0	0.0	0.0	BP	0	Grundstellung
4	0.00	0.00	0.00	0.00	0.00	0.00						0.0	0.0	0.0	0.0	BP	0	Kommentar
5	0.00	0.00	0.00	0.00	0.00	0.00						0.0	0.0	0.0	0.0	BP	0	Kommentar
6	0.00	0.00	0.00	0.00	0.00	0.00						0.0	0.0	0.0	0.0	BP	0	Kommentar
7	0.00	0.00	0.00	0.00	0.00	0.00						0.0	0.0	0.0	0.0	BP	0	Kommentar
8	0.00	0.00	0.00	0.00	0.00	0.00						0.0	0.0	0.0	0.0	BP	0	Kommentar
9	0.00	0.00	0.00	0.00	0.00	0.00						0.0	0.0	0.0	0.0	BP	0	Kommentar

Bestücken

Maschine leer **Bitte Startschalter betätigen!** Taktzeit: 18.22 s

Friedrich CNC riveting machines with indexing table

CNC riveting machines in modular design for universal use. The 3 standard sizes can be combined with different coordinate axes and riveting machines. Special versions for particular applications are configurable in various variants.

- steel welded frame
- available in 3 sizes, with adjustable foot rest
- protective shell with frames from aluminium sections
- polycarbonate panes for good visibility
- coordinate system with recirculating ball screws
- riveting areas from 280x180mm to 500x350mm
- electrically-operated rotary indexing table with 2 or 4 fixed indexing stations and braking motor
- NC rotary indexing tables
- indexing table \varnothing 650/900/1200 mm
- automatic tool changer
- grab containers
- C-shaped frames in different heights and projections
- pneumatically- or hydraulically-operated radial point riveting machines can be used
- digital high-speed servo drive with motion control and absolute value transducer
- Friedrich CNC control with riveting process monitoring, touchscreen panel with Windows CE4.2 user interface



Special features and advantages:

- minimum distances between rivets and different rivet heights can be achieved
- processing of several workpieces (several workpieces on workholding fixture) is possible
- different rivets can be processed in one operation
- high flexibility thanks to short changeover times and a large programme memory
- cost reduction due to picking and placing operation in parallel with the primary processing time
- short distances to cover for picking and placing and customised grab containers make the workplace ergonomic
- menu navigation makes programming plain and simple
- high movement speed, up to 400 mm/s
- high acceleration rate with high positioning accuracy

Special versions:

- indexing table up to 2000 mm and 8 fixed indexing stations
- riveting area up to 500x1200 mm
- configuration with 2 riveting machines
- handling robot and feed stations
- further special versions on request

● Friedrich CNC riveting machines with transfer system

Friedrich CNC riveting machines with transfer system are intended for use in manufacturing lines. Coded work holding fixtures and customised interfaces make it possible to connect several CNC riveting machines or to link them up with other manufacturing systems, thus enabling a high degree of automation.

- steel welded frame
- protective shell with frames from aluminium sections, with polycarbonate panes for good visibility
- coordinate system with linear units and ball screws
- riveting areas 160x160 mm to 400x320 mm
- digital high-speed servo drive with motion control and absolute value transducer
- transfer systems for coded workholding fixtures, sizes from 240x240mm to 480x400mm
- integrated lifting station to support the workholding fixtures
- C-shaped frames in different heights and projections
- pneumatically- or hydraulically-operated radial point riveting machines can be used
- Friedrich CNC control with riveting process monitoring, touchscreen panel with Windows CE4.2 user interface and various interfaces for data transfer

Special features and advantages:

- minimum distances between rivets and different rivet heights can be achieved
- processing of several workpieces (several workpieces on workholding fixture) is possible
- high flexibility thanks to short changeover times and a large programme memory
- cost reduction due to picking and placing operation in parallel with the primary processing time
- menu navigation makes programming plain and simple
- high movement speed, up to 400mm/s
- high acceleration rate with high positioning accuracy
- use of different transfer systems
- integration into other manufacturing systems is possible
- special versions on request



● Friedrich CNC riveting machines with machine table

Friedrich CNC riveting machines with stationary machine table were developed to serve as stand-alone workstations in particular for big and heavy workpieces. The machines are of simple design and require only one workholding fixture, which means that clamping and component query devices can be obtained at low cost.

- steel welded frame
- protective shell with frames from aluminium sections, with polycarbonate panes for good visibility
- coordinate system with linear units and ball screws
- riveting area up to 500x1600 mm
- digital high-speed servo drive with motion control and absolute value transducer
- C-shaped frames in different heights and projections
- pneumatically- or hydraulically-operated radial point riveting machines can be used.
- Friedrich CNC control with riveting process monitoring, touchscreen panel featuring Microsoft Windows
- various interfaces for data transfer

Special features and advantages:

- minimum distances between rivets and different rivet heights can be achieved
- processing of several workpieces (several workpieces on workholding fixture) is possible
- high flexibility thanks to short changeover times and a large programme memory
- menu navigation makes programming plain and simple
- high movement speed, up to 400 mm/s
- high acceleration rate with high positioning accuracy
- Special versions on request

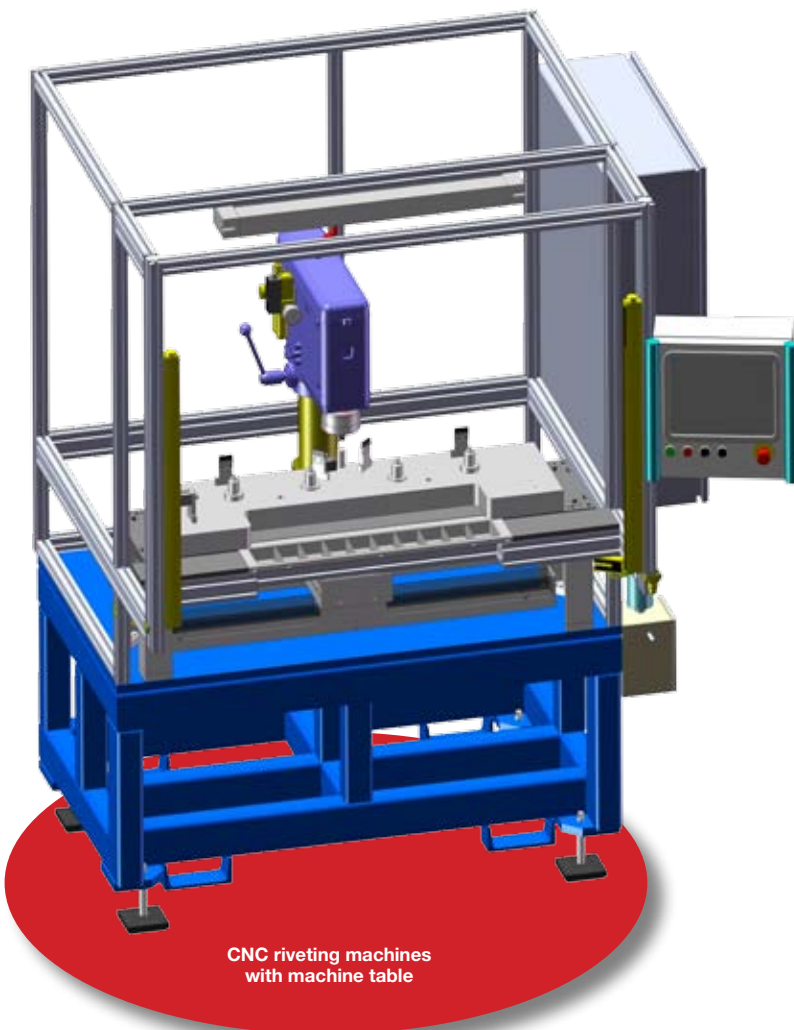

● Friedrich CNC riveting machines used as a module

The CNC riveting module was developed in particular for use on special-purpose machines and in system engineering. The base plate, coordinate axes, C-shaped frame and the riveting machine can be configured to match the installation situation they are intended for. The Friedrich CNC control with its touchscreen panel and a clearly laid out tabular structure is designed for easy programming.

- solid, torsion-resistant base plate with mounting bores
- coordinate system with linear units and ball screws
- riveting areas 100x200 mm to 350x500 mm
- digital high-speed drive with motion control
- C-shaped frames in different heights and projections
- pneumatically- or hydraulically-operated radial point riveting machines can be used
- Friedrich CNC control with riveting process monitoring,
- switchgear cabinet for individual installation
- various interfaces for data transfer

Special features and advantages:

- can be used as single module or together with others
- can be integrated into special-purpose machines and manufacturing systems
- minimum distances between rivets can be achieved
- high movement speed, up to 400m/s
- high acceleration rate with high positioning accuracy

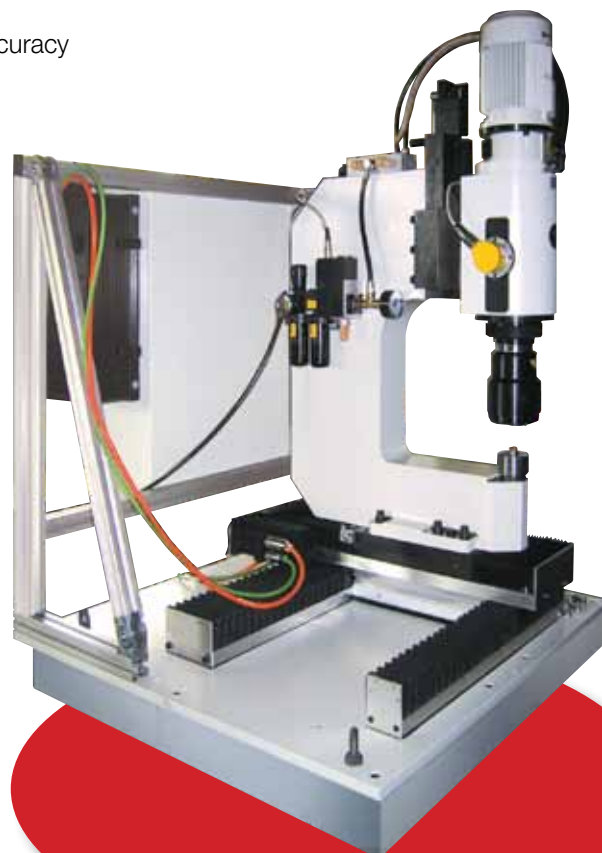

CNC riveting machine
used as a module

● Friedrich CNC riveting machines with 5 axes

When bent or curved components are to be riveted, conventional CNC riveting machines with 3 axes will not be able to reach all riveting points due to the different angles which exist on the components. Friedrich's 5-axis CNC riveting machine with its 2 additional CNC axes makes it possible to process complex components in one clamping operation. By reducing thus the number of additional sequences of operation, significant cost savings as well as lower labour and tooling costs can be achieved.



- steel welded frame
- protective shell with frames from aluminium sections
- polycarbonate panes
- coordinate system with linear units and ball screws, riveting areas 180x280 mm to 350x500 mm
- digital high-speed drive with motion control
- rotary indexing table with 2 or 4 fixed indexing stations and braking motor
- indexing table \varnothing 900/1200 mm is standard
- C-shaped frame with 2 CNC axes rotatable through $\pm 15^\circ$ at 2 levels
- riveting unit with 80 mm spindle stroke
- CNC control with riveting process monitoring
- various interfaces for data transfer

Special features and advantages:

- angled or curved components can be processed
- minimum distances between rivets can be achieved
- cost reduction due to picking and placing operation in parallel with the primary processing time
- high movement speed, up to 400 mm/s
- high acceleration rate with high positioning precision

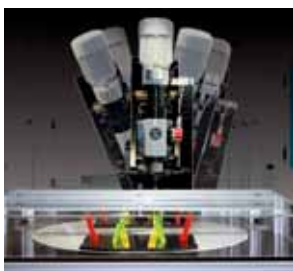

● Friedrich CNC riveting machines with handling robot

The CNC riveting machine with handling robot is a further innovation from the house of Friedrich. Due to its enhanced degree of automation it represents a new dimension in riveting technology. Its construction and properties are based on the proven design of the CNC riveting machines with indexing table. It is equipped with a Friedrich CNC control with extended user interface and process visualisation.

- 3 sizes
- indexing table \varnothing 650/900/1200mm
- riveting areas from 280x180mm to 500x350mm
- coordinate system with recirculating ball screws
- electrically-operated rotary indexing table with 2 or 4 fixed indexing stations and braking motor
- NC rotary table (optional)
- automatic tool changer
- C-shaped frames in different heights and projections
- freely programmable handling robot
- Friedrich CNC control with riveting process monitoring
- touchscreen panel 12" with Windows CE4.2 user interface
- adaptable sorting and feed stations

Special features and advantages:

- compact design, thus little space required
- enhanced degree of automation
- cost reduction due to picking and placing operation in parallel with the primary processing time
- cost reduction by cycle time reduction
- menu navigation makes programming plain and simple
- each riveting programme can be assigned its own robot handling sequence. Robots by Kuka, Adept, ABB, and Universal Robots can be used.

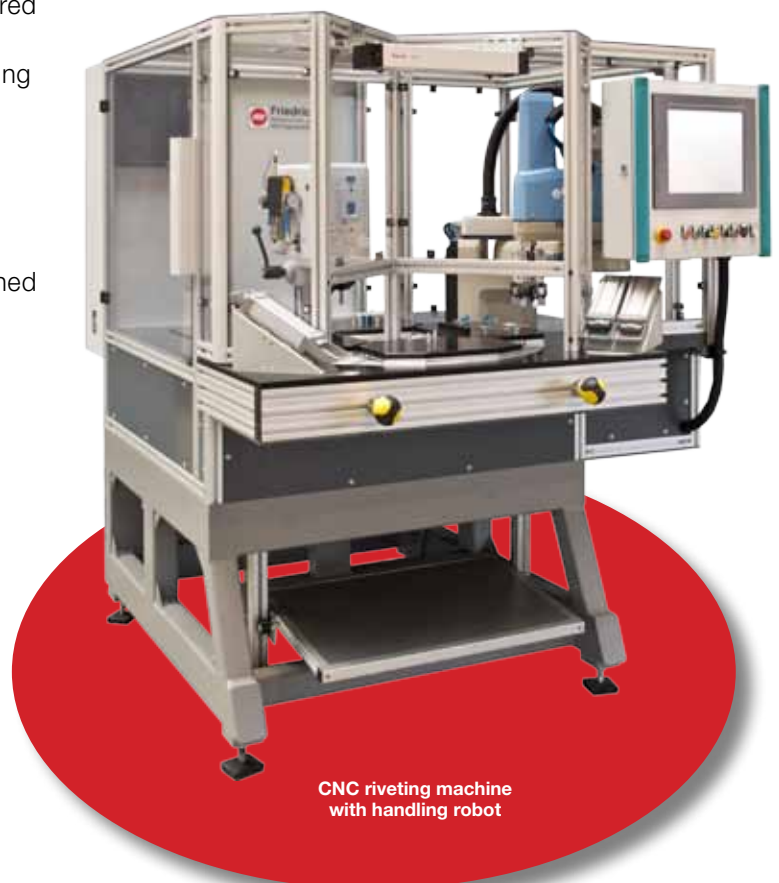

CNC riveting machine with handling robot

Electrically-operated press P602 closed version

For pressing, blanking, reshaping, stamping, joining

Unique press technology by Friedrich, pressing force 60 kN, available in 3 versions. The closed version of the press stand is intended for the processing of smaller parts, while the two open versions are suited for the use of various tools or for bulky workpieces. The stand and slide, which are both made of high-strength nodular graphite casting, ensure a low resilience and a high pressing accuracy. The basic equipment comprises a machine table with worktop and foot rest as well as a three-channel fail-safe control with actuation by two-hand control. The low-noise electromechanical drive enables an oilless and airless operation and offers an ergonomically-designed workplace. Model P602 is a plug-and-play machine. Easy handling, short set-up times and the little space it requires (0.75 m² only) make this press very versatile.



Electrically-operated press P602 closed version

Special features and advantages:

- low-noise
- oilless and airless operation
- low resilience
- easy handling
- short set-up time
- safe press control conforming to accident-preventing regulations
- with EC type examination certificate
- requires a space of only 0.75 m²
- with dwell time at the BDC for longer pressing

Technical Data:

Pressing force	60 kN
Stroke	10 - 60 mm
Motor output	1,1 kW
Clamping area	200 - 275 mm
Projection	90 - 150 mm
Installation height	140 - 300 mm
Plunger bore	20H7
Weight	300 kg
Size (LxWxH) in mm	750 x 1.000 x 1.500



Stroke setting



Example of use



Control

Electrically-operated press P602 open versions

The operation and the properties of these versions are identical to those of the closed version. The different shape of the press stand, however, provides for additional applications. The bigger workspace available enables the use of bigger tools and, in consequence, the processing of long and bulky workpieces.



Electrically-operated press P602 open version



Open version wide press stand



Open version narrow press stand



Example of use open version

● Special-purpose machines

The production of special-purpose machines has decades of tradition at Friedrich's. The wide array of Friedrich's special-purpose machine manufacture reaches from semi-automatic indexing table machines to fully-automatic large plants including test stations, laser shaping and robot handling:

- automatic winding machines for electric coils
- valve testing machines and soot measuring apparatus
- ball joint and roller press-in machines
- machines for the manufacture of fuel pumps and gas springs
- manufacturing plants for lock systems and seat adjusters

The above is just a small selection from the machinery and equipment produced by Friedrich. The requirements towards the machines are discussed and the solutions we can offer are devised in close cooperation with our customers. Our machines are designed using the latest CAD technology. Thanks to our in-house production with recent CNC machines and an assembly by experienced personnel the design can be transformed into a top-quality product within a narrow time frame. From the development of the machine to its delivery, our customer is supplied from only one source. An efficient After Sales Service guarantees a high rate of utilisation of the machines.

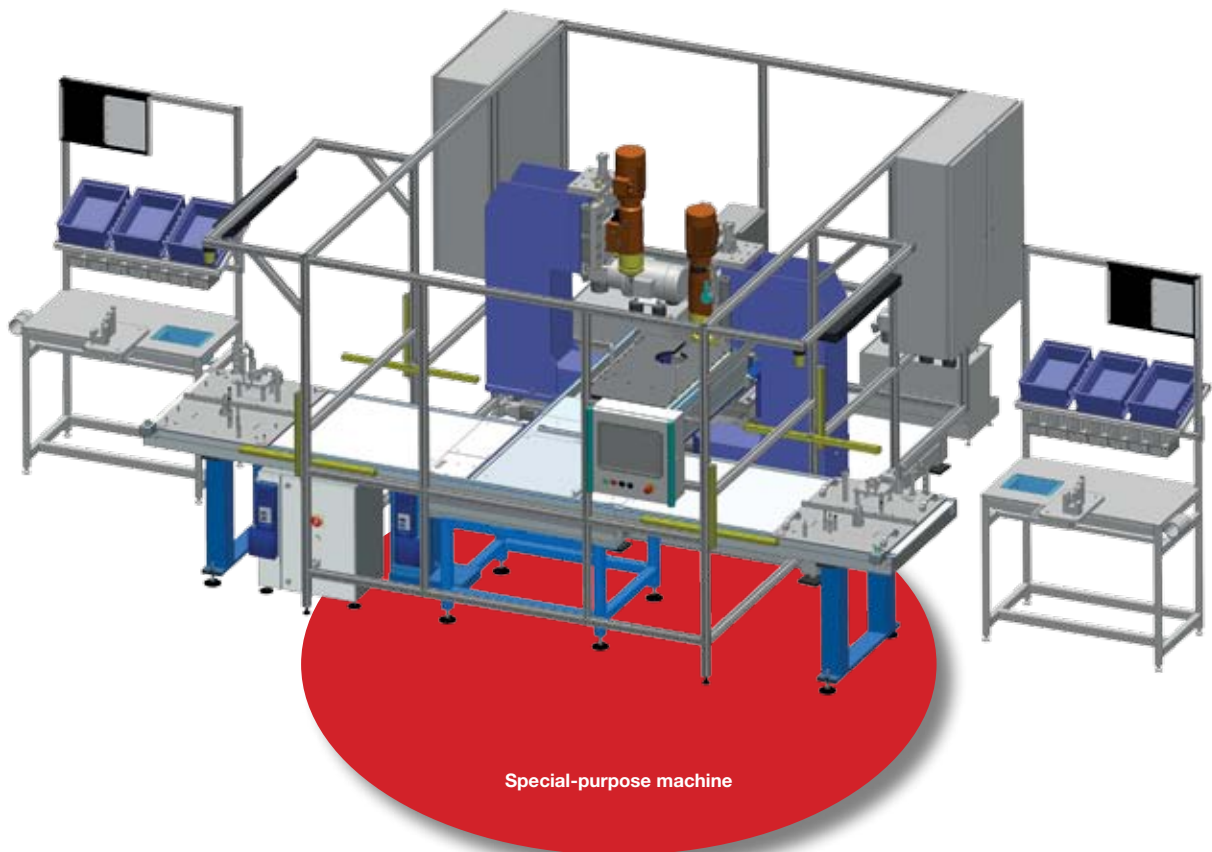

● Assembly systems

The development and production of assembly systems for a variety of highly diverse industrial products is a further foothold of the Friedrich business. This business area, too, can look back on many years of experience backed up by the know-how from riveting technology and special-purpose machine manufacturing. The range of machinery already supplied is wide and varied:

- automatic tyre fitting machines and ball bearing fitting machines
- assembling machines for carburetors and diaphragm governors
- automatic assembling machines for latch striker linkages and seat belt pretensioners
- transfer systems for window fittings and door locks
- assembly systems for electronics and drive kinematics

The delivery programme also comprises workplace systems for manual assembly as well as the necessary equipment for expanding and updating existing systems. Competent and comprehensive consultation forms a sound basis for analysis and problem-solving approaches. Development and design use the latest CAD technology and takes place in close cooperation with the customer. Our in-house manufacturing, promptly followed by the respective assembly work, keeps delivery times short.

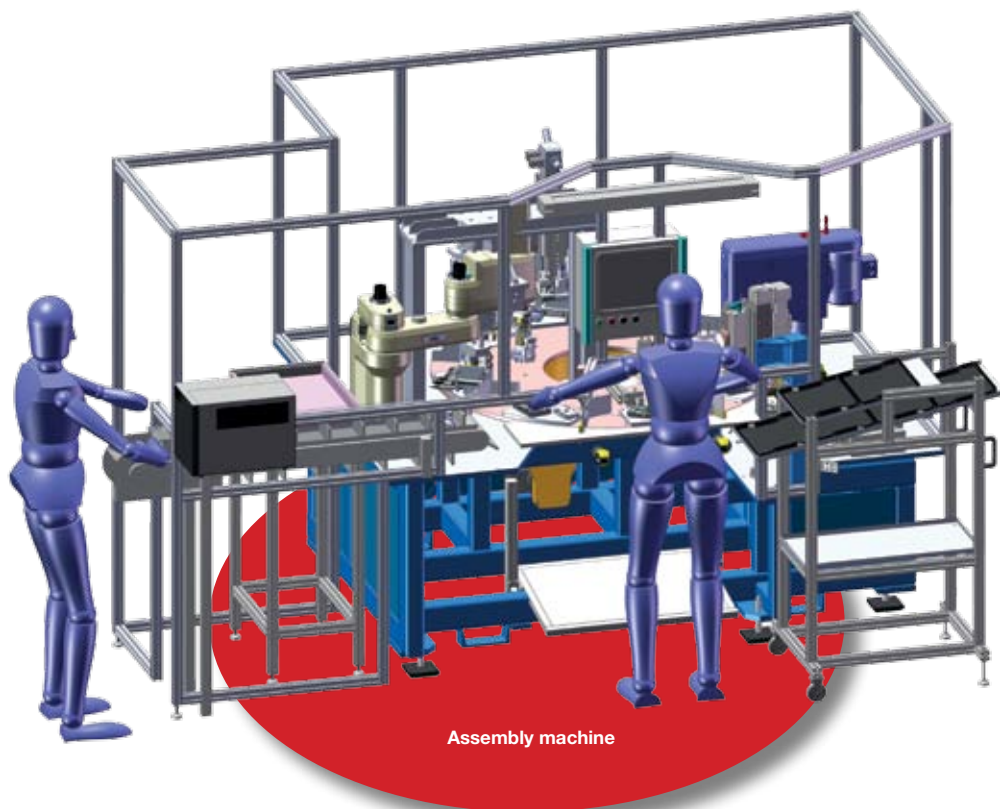

● Bushing machines

The purpose of the bushing technology is to introduce plain bearing bushes into joints by pressing the bush in and pre-processing it. To achieve a high quality and an identical torque characteristic of the finished bearings, the bush is calibrated after finish crimping.

Bushing unit types and sizes:

4 preferably used model ranges exist:

- hydropneumatic feed unit up to 15kN at a stroke of 100/12mm
- hydropneumatic feed unit up to 30kN at a stroke of 100/30mm
- electric servo feed unit up to 30kN at a stroke of 300mm max.
- electric servo feed unit up to 60kN at a stroke of 250mm max.

Fields of application:

Bush diameters:

- \varnothing 4 to \varnothing 30mm with wall thicknesses of 0.3 to 1.0 mm

Bush materials:

- teflon-coated sheet-metal bushes or bushes with fabric backing, with/without crimping
- connectors with/without counter-washer

Quality Assurance:

The Friedrich bushing units can, of course, be combined with electronic quality assurance systems. To this effect various controls and programmes are available which are based on pressure vs. displacement measurements and matched to the special conditions of bushing.

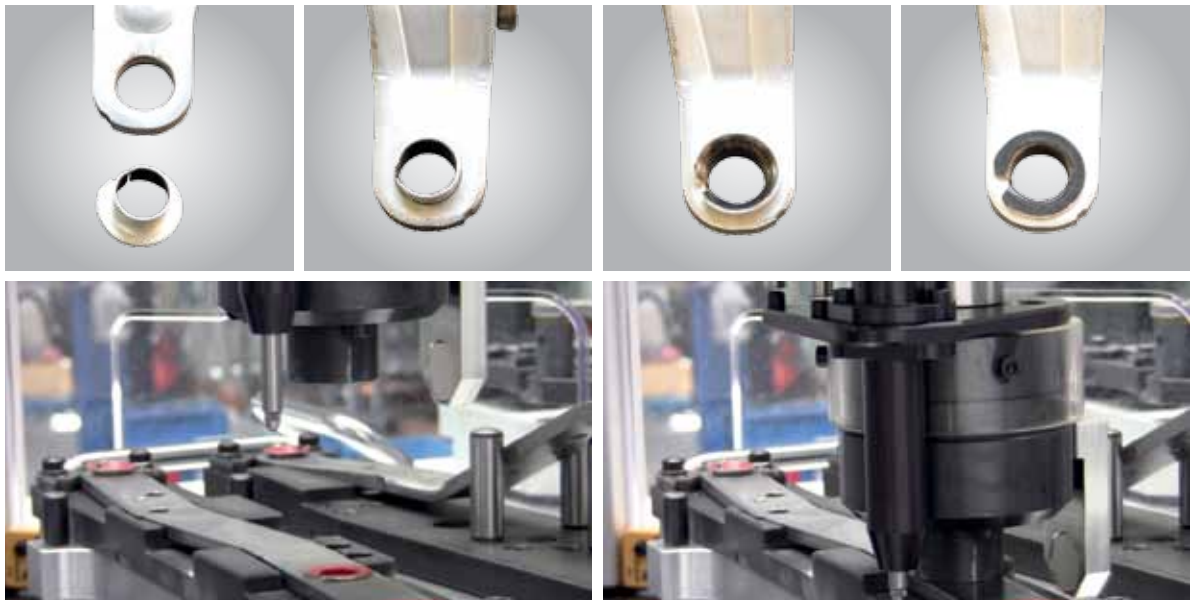

● Services offered

Qualified advisory services:

- competent and experienced field staff
- comprehensive and serious quotations
- assistance in optimising manufacturing processes

Developing individual solutions:

- customised sample rivetings in our own test laboratory
- meeting of customers' specifications, contained for example in requirements specifications
- assistance in the implementation of the riveting jobs, provided to our customers by our applications technicians and development engineers

First-class product choice:

- Friedrich products are available in a great diversity of variants
- targeted selection of machines for each and every application
- customers' special requests are taken care of and implemented

Comprehensive after-sales service:

- skilled and experienced service technicians and programmers assist the customer when the riveting machines and plants are started up at customer's premises
- machine malfunctions are remedied by the respective specialists within short notice
- in emergencies machines can be made available to the customer on loan
- repair work and conversions at the plant are carried out at very short notice
- a well-assorted parts store ensures a high degree of availability and a quick shipment of spare parts to any place in the world
- riveting tools and fixtures are custom-built on our own manufacturing equipment

Test laboratory



How to reach us

Wherever you come from, you will find Remshalden easily and quickly to reach. Whether you arrive in Stuttgart by plane or by train: simply take the suburban railway line S2 in direction of Schorndorf and step off the train at Remshalden-Geradstetten – no need to change trains! Only a short distance of 250 m is now left for you to cover by foot to reach us. When you travel by car take exit Geradstetten of B29.

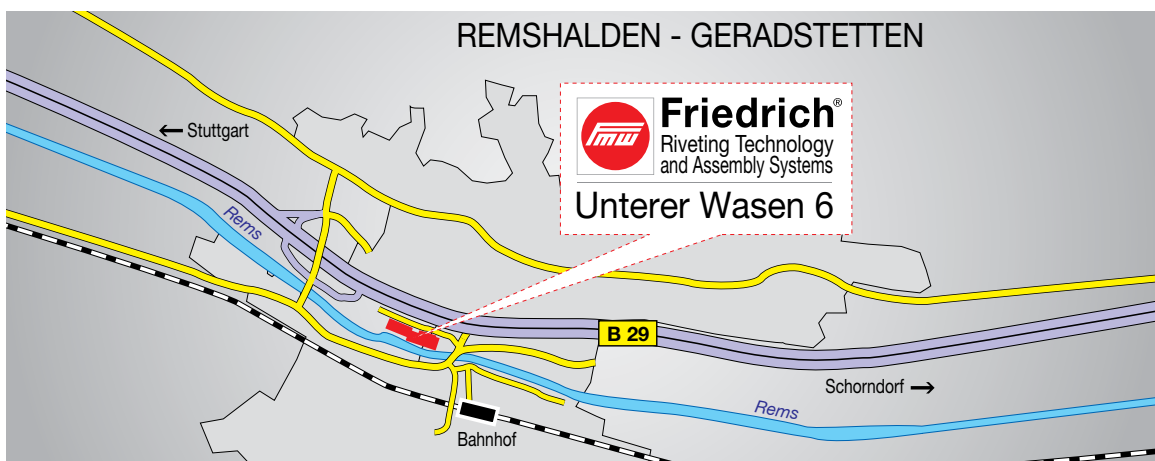

Headquarters

● **Maschinen und Werkzeugbau
D. Friedrich GmbH & Co. KG**
 Unterer Wasen 6
 73630 Remshalden
 Germany
 Telephone: +49 (0) 7151/97 90 5 - 0
 Telefax: +49 (0) 7151/97 90 5 - 51
 info@fmw-friedrich.de

Sales and distribution – Germany

● **Frank Werner**
 Dipl.-Ing. (TU)
 Steinsfeld 14, 98528 Suhl
 Deutschland
 Tel.: +49 (0) 36 81 / 42 35 57
 Fax: +49 (0) 36 81 / 42 23 90
 werner@fmw-friedrich.de

● **Ralf Zschörner**
 Dipl.-Ing. (FH)
 Wankelstr. 12, 46244 Bottrop
 Deutschland
 Tel.: +49 (0) 170 / 52 77 265
 Fax: +49 (0) 3212 / 106 3876
 zschorner@fmw-friedrich.de

International sales and distribution

● **China**
Shanghai Systence Electronics Co., Ltd.
 1st Floor, D4 Building, Area D, Lane 1340
 Jin Shajiang Rd., 200333 Shanghai, Volksrepublik China
 Tel.: +86 21 62645948-8002 oder +86 13818212454
 Fax: +86 21 52658817
 Internet: www.systence.com
 E-Mail: jacky@systence.com

● **Czech Republic / Slovakia**
RIVETEC s.r.o.
 Albrechtice nad Vltavou 16,
 398 16 Albrechtice nad Vltavou
 Tschechien
 Tel.: +420 382 206711
 Fax: +420 382 206719
 Internet: http://www.rivetec.cz
 E-Mail: info@rivetec.cz

● **Netherlands, Belgium, Luxembourg**
Germo Techniek BV
 Zwarte Zee 38-40, 3144 DE Maassluis, Niederlande
 Tel.: +31 10 5937260
 Fax: +31 10 5928538
 Internet: www.germotechniek.nl
 E-Mail: pbos@germotechniek.nl

● **MonTec cz, s.r.o.**
 Domažlická 1161/5, 130 00 Praha 3
 Tschechien
 Tel.: +420 731 171 077 (Mobil)
 Fax: +420 222 716685
 Internet: www.montec.cz
 E-Mail: domorad@montec.cz

● **Austria**
Maxxom Automation GmbH
 Gewerbegebiet Salzweg 1
 4894 Oberhofen am Irrsee, Österreich
 Tel.: +43 6213 200 53-0
 Fax: +43 6213 200 53-22
 Internet: www.maxxom-automation.at
 E-Mail: office@maxxom-automation.at

● **Republic of Korea**
EDT Corporation
 4-40, Yongsu-gil, Jeongnam-myeon
 Hwaseong-si, Gyeonggi-do, 445-966
 Rep. of Korea
 Tel.: +82-31-377-9792
 Fax: +82-31-377-9793
 Internet: www.edtcorp.co.kr
 E-Mail: edt_dalian@naver.com

● **Russia**
Georg Schmik
 Äußere Ailingerstr. 113, 88046 Friedrichshafen, Deutschland
 Tel.: +49 (0) 75 41 / 59 15 93
 Mobil: +49 (0) 176 58484877
 E-Mail: schmik_georg@gmx.de

● **Turkey**
Epiri Makina
 Yalova Yolu BUTTIM Is Merkezi A Blok
 Kat:4 No: 1802 Osmangazi -
 Bursa / Türkiye
 Tel.: +90 224-211 15 56
 Fax: +90 224-211 24 59
 Internet: www.epirimakina.com
 E-Mail: info@epirimakina.com

● **Poland**
Automationstechnik Sp. z.o.o.
 ul. Rzemie Inicza 1, 30-363 Krakow, Polen
 Tel.: +48 12 2637755
 Fax: +48 12 2637756
 Internet: www.automationstechnik.pl
 E-Mail: biuro@automationstechnik.pl